

Introducing Robot with integrated buffer

Expertise 3
companies
combined in 1
product

Integrated
buffering
robot



Modular
design

Digitalization



One control
cabinet
location



Watch Interview

<https://youtu.be/OxEbYLPoyfo>



Integrated Buffering Robot

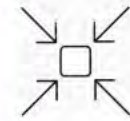

Narrow footprint

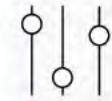

Easy operation

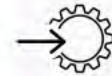

Integrated functions



Minimized investment
time and costs

■ NARROW FOOTPRINT

2040 mm

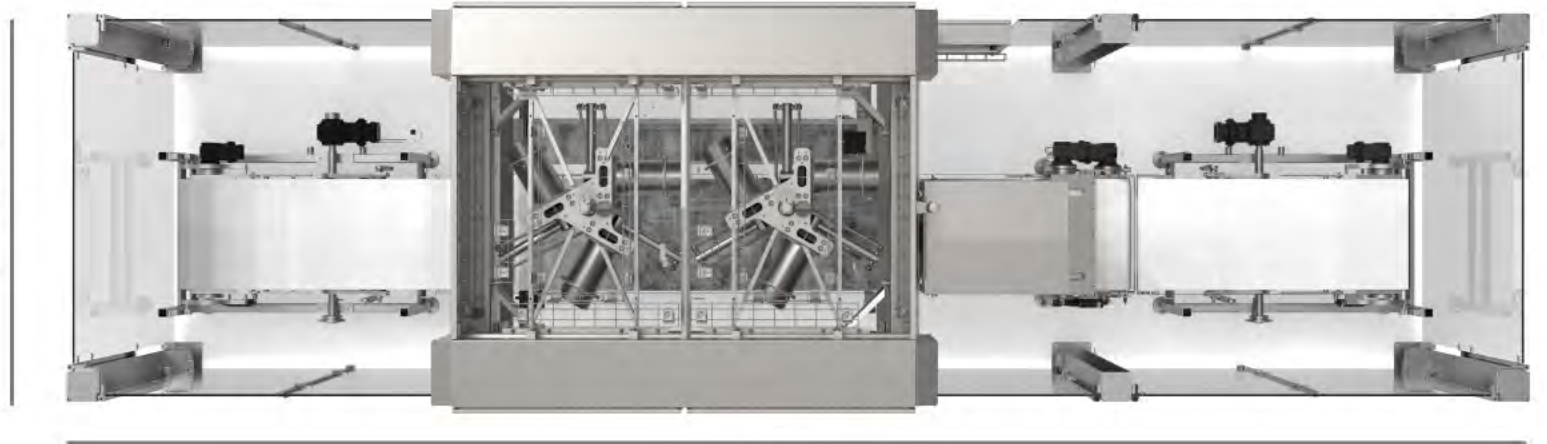

7436 mm



Our compact design saves space and money, allowing, for example, other plant investments or higher profitability.

ROTZINGER GROUP



With one controller and one setup philosophy, our solution is easy to operate and reduces the need for costly linking conveyors and frames.

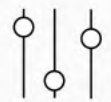

EASY OPERATION

INTEGRATED FUNTIONS



Co-flow or counterflow? Get the best of both words in one single narrow solution.

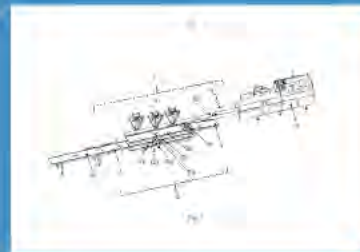
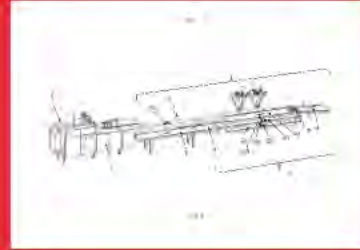

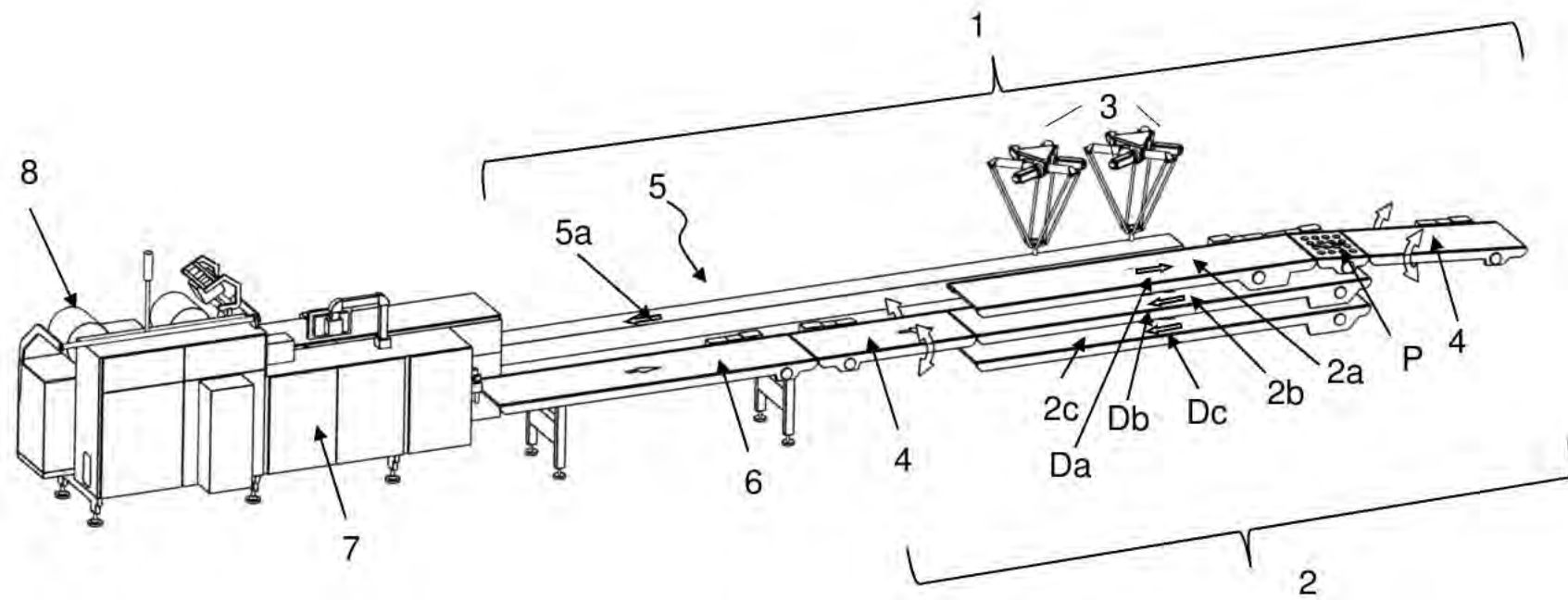
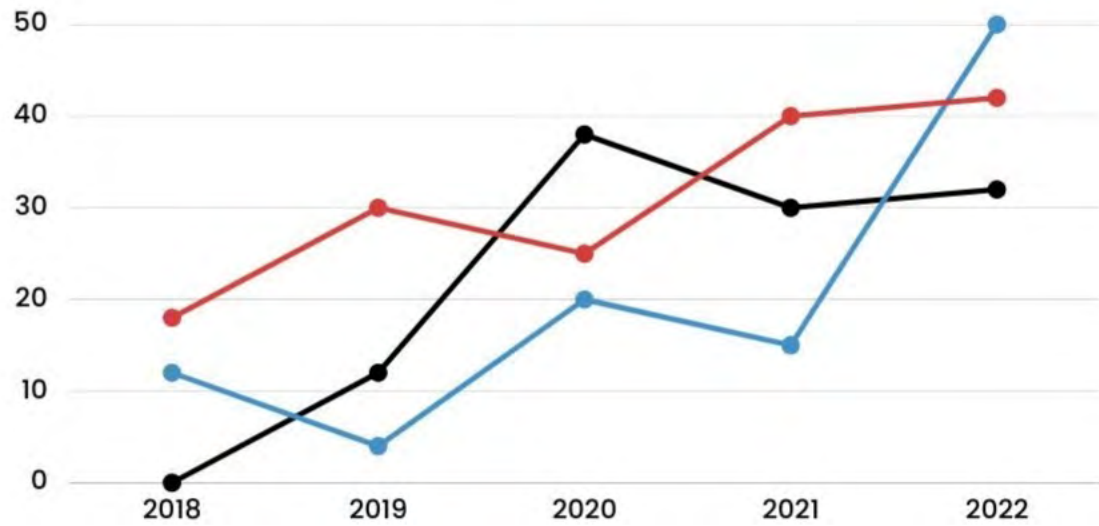

Fig. 2



MINIMIZED INVESTMENT TIME AND COSTS

Our compact design saves space and money, allowing, for example, other plant investments or higher profitability. By taking the best out of both worlds, efficiency and speed, we can offer you a solution to minimize investment costs and even get an early start on production.



Expertises of 3 Companies

DEMAUREX 

ROTZINGER 

TRANSVER 



Holistic approach



Proven solutions



Single supplier



HOLISTIC APPROACH

Experience the best of three companies in one powerful product. Our holistic approach brings together proven solutions from different fields of applications and functions with robotics, buffering, and hygiene conveying.

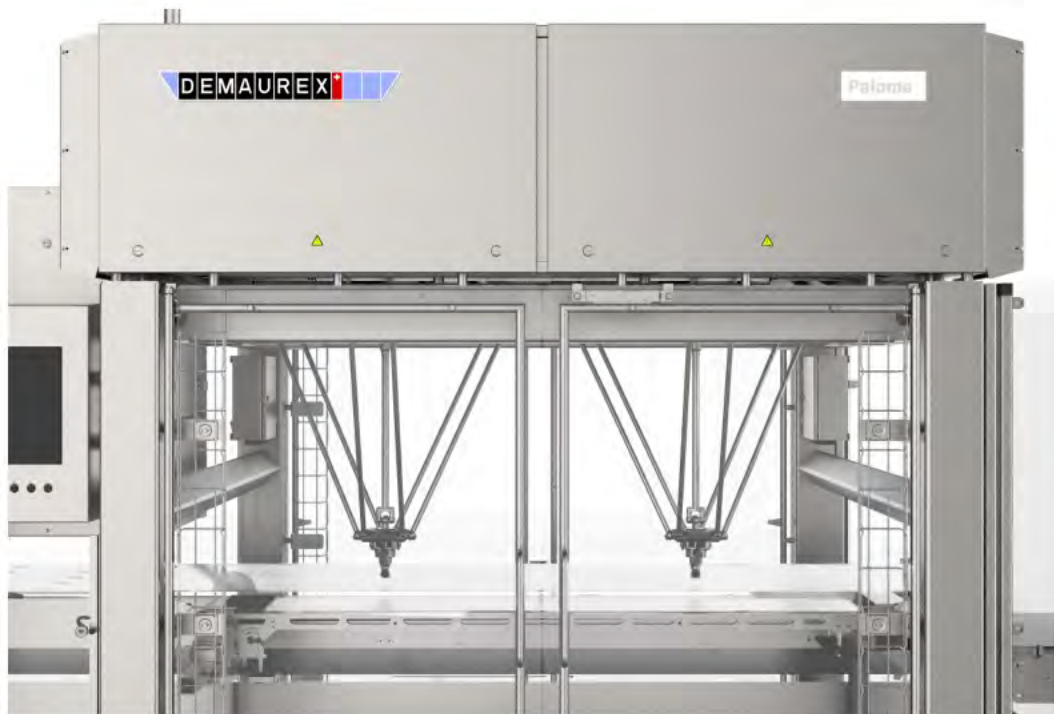



PROVEN SOLUTIONS



HUG AG, Malzers

«A lot must go hand in hand when expanding our production facility. Trust, precise planning, and tailor-made, far-sighted solutions are fundamental.

For the **conveyor lines**, the **flow regulation solutions**, and the **pick and place line**, we rely on the Rotzinger Group a well-known partner who does just that. Thanks to their evident passion and visible competence, the Rotzinger Group will continue to be an essential partner in the future when it comes to finding and implementing solutions in product handling. »

Ernst Huwiler, Technical Project Manager

One Control Cabinet Location



Hassle-free maintenance,
compact design, optimal
building investment.



ONE CONTROL CABINET LOCATION

ROTZINGER GROUP 

Experience hassle-free maintenance with just one control cabinet location. Maximize your production efficiency by utilizing the saved space for more production lines. Get a clear and easy overview for maintenance tasks and keep your operations running smoothly.





MODULAR DESIGN

Our innovative approach makes shipment a breeze, allowing for fast and hassle-free ramp-up. Enjoy a turnkey solution that maximizes project success, thanks to our modular design that can be customized to your specific needs.

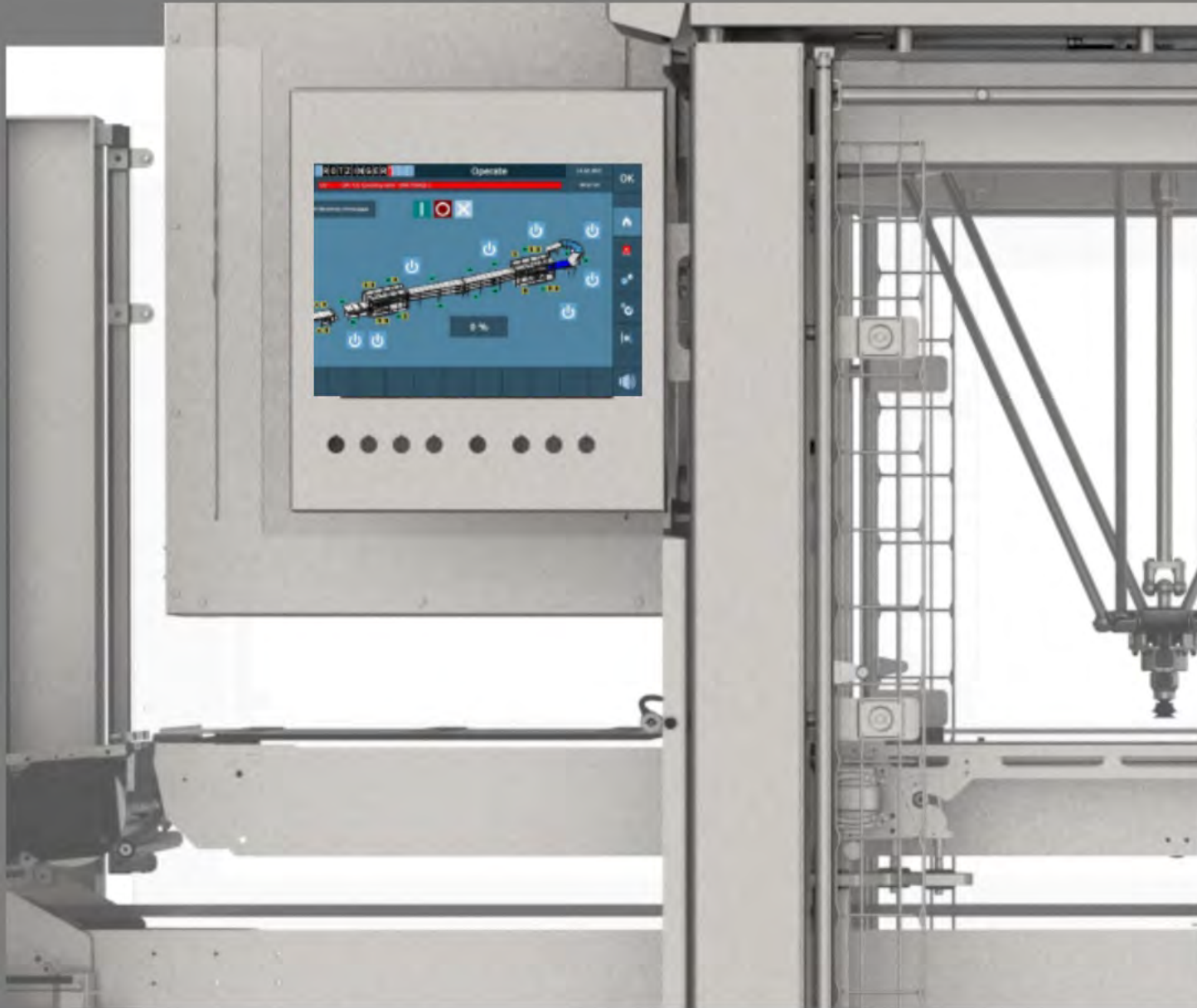

DIGITALIZATION

Transform your production with our Digital Factory Suite. Harness the power of data to steer control and optimize your production processes. With the ability to manage present operations and predict future trends, you'll stay ahead of the competition. Gain real-time data insights to make informed decisions quickly, and watch your production efficiency skyrocket to new heights.



Engineered with:
ROTZINGER
TRANSVER

Paloma

O



C

C



C



ROTZINGER GROUP 